

BLF6G10L-260PRN; BLF6G10LS-260PRN

Power LDMOS transistor

Rev. 2 — 12 July 2013

Product data sheet

1. Product profile

1.1 General description

260 W LDMOS power transistor for base station applications at frequencies from 700 MHz to 1000 MHz.

Table 1. Typical performance

Typical RF performance at $T_{case} = 25\text{ °C}$ in a class-AB production test circuit.

Mode of operation	f (MHz)	V_{DS} (V)	$P_{L(AV)}$ (W)	G_p (dB)	η_D (%)	ACPR (dBc)
2-carrier W-CDMA	920 to 960	28	40	22.0	26.5	-39 ^[1]

[1] Test signal: 3GPP test model 1; 1 to 64 DPCH; PAR = 7.5 dB at 0.01 % probability on CCDF per carrier; carrier spacing 5 MHz.

CAUTION



This device is sensitive to ElectroStatic Discharge (ESD). Therefore care should be taken during transport and handling.

1.2 Features and benefits

- Typical 2-carrier W-CDMA performance at frequencies of 920 MHz and 960 MHz, a supply voltage of 28 V and an I_{DQ} of 1800 mA:
 - ◆ Average output power = 40 W
 - ◆ Power gain = 22.0 dB
 - ◆ Efficiency = 26.5 %
 - ◆ ACPR = -39 dBc
- Easy power control
- Integrated ESD protection
- Excellent ruggedness
- High efficiency
- Excellent thermal stability
- Designed for broadband operation (700 MHz to 1000 MHz)
- Internally matched for ease of use
- Compliant to Restriction of Hazardous Substances (RoHS) Directive 2002/95/EC



1.3 Applications

- RF power amplifiers for GSM, GSM EDGE, W-CDMA and CDMA base stations and multi carrier applications in the 700 MHz to 1000 MHz frequency range

2. Pinning information

Table 2. Pinning

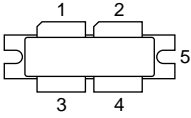
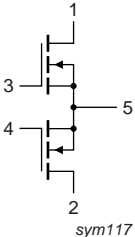
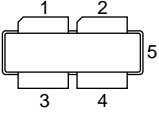
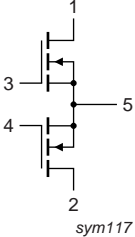
Pin	Description	Simplified outline	Graphic symbol
BLF6G10L-260PRN (SOT539A)			
1	drain1		 sym117
2	drain2		
3	gate1		
4	gate2		
5	source		
BLF6G10LS-260PRN (SOT539B)			
1	drain1		 sym117
2	drain2		
3	gate1		
4	gate2		
5	source		

[1] Connected to flange.

3. Ordering information

Table 3. Ordering information

Type number	Package		
	Name	Description	Version
BLF6G10L-260PRN	-	flanged balanced LDMOST ceramic package; 2 mounting holes; 4 leads	SOT539A
BLF6G10LS-260PRN	-	earless flanged balanced LDMOST ceramic package; 4 leads	SOT539B

4. Limiting values

Table 4. Limiting values

In accordance with the Absolute Maximum Rating System (IEC 60134).

Symbol	Parameter	Conditions	Min	Max	Unit
V_{DS}	drain-source voltage		-	65	V
V_{GS}	gate-source voltage		-0.5	+13	V
I_D	drain current		-	64	A
T_{stg}	storage temperature		-65	+150	°C
T_j	junction temperature		-	200	°C

5. Thermal characteristics

Table 5. Thermal characteristics

Symbol	Parameter	Conditions	Typ	Unit
$R_{th(j-case)}$	thermal resistance from junction to case	$T_{case} = 80\text{ °C}; P_L = 40\text{ W}$	0.28	K/W

6. Characteristics

Table 6. Characteristics

$T_j = 25\text{ °C}$; values per section unless otherwise specified.

Symbol	Parameter	Conditions	Min	Typ	Max	Unit
$V_{(BR)DSS}$	drain-source breakdown voltage	$V_{GS} = 0\text{ V}; I_D = 1.8\text{ mA}$	65	-	-	V
$V_{GS(th)}$	gate-source threshold voltage	$V_{DS} = 10\text{ V}; I_D = 180\text{ mA}$	1.4	1.9	2.4	V
V_{GSq}	gate-source quiescent voltage	$V_{DS} = 28\text{ V}; I_D = 1000\text{ mA}$	1.45	2.1	2.55	V
I_{DSS}	drain leakage current	$V_{GS} = 0\text{ V}; V_{DS} = 28\text{ V}$	-	-	2.8	μA
I_{DSX}	drain cut-off current	$V_{GS} = V_{GS(th)} + 3.75\text{ V}; V_{DS} = 10\text{ V}$	24.1	30	-	A
I_{GSS}	gate leakage current	$V_{GS} = 11\text{ V}; V_{DS} = 0\text{ V}$	-	-	280	nA
g_{fs}	forward transconductance	$V_{DS} = 10\text{ V}; I_D = 9\text{ A}$	7.02	12	-	S
$R_{DS(on)}$	drain-source on-state resistance	$V_{GS} = V_{GS(th)} + 3.75\text{ V}; I_D = 6.3\text{ A}$	0.053	0.1	0.165	Ω

7. Application information

Table 7. 2-carrier W-CDMA Application information

Class-AB production test circuit; PAR 7.5 dB at 0.01 % probability on CCDF; 3GPP test model 1; 1 to 64 DPCH; $f_1 = 917.5\text{ MHz}$; $f_2 = 922.5\text{ MHz}$; $f_3 = 957.5\text{ MHz}$; $f_4 = 962.5\text{ MHz}$; RF performance at $V_{DS} = 28\text{ V}; I_{Dq} = 1800\text{ mA}; T_{case} = 25\text{ °C}$; unless otherwise specified.

Symbol	Parameter	Conditions	Min	Typ	Max	Unit
$P_{L(AV)}$	average output power		-	40	-	W
G_p	power gain	$P_{L(AV)} = 40\text{ W}$	19.8	22.0	-	dB

Table 7. 2-carrier W-CDMA Application information ...continued

Class-AB production test circuit; PAR 7.5 dB at 0.01 % probability on CCDF; 3GPP test model 1; 1 to 64 DPCH; $f_1 = 917.5$ MHz; $f_2 = 922.5$ MHz; $f_3 = 957.5$ MHz; $f_4 = 962.5$ MHz; RF performance at $V_{DS} = 28$ V; $I_{Dq} = 1800$ mA; $T_{case} = 25$ °C; unless otherwise specified.

Symbol	Parameter	Conditions	Min	Typ	Max	Unit
RL_{in}	input return loss	$P_{L(AV)} = 40$ W	-	-10.0	-6.0	dB
η_D	drain efficiency	$P_{L(AV)} = 40$ W	25.0	26.5	-	%
ACPR	adjacent channel power ratio	$P_{L(AV)} = 40$ W	-	-39	-35	dBc

Table 8. 1 carrier W-CDMA Application information

Class-AB production test circuit; PAR 7.5 dB at 0.01 % probability on CCDF; 3 GPP test model 1; 1 to 64 DPCH; $f_1 = 960$ MHz; RF performance at $V_{DS} = 28$ V; $I_{Dq} 1800$ mA; $T_{case} = 25$ °C; unless otherwise specified.

Symbol	Parameter	Conditions	Min	Typ	Max	Unit
PAR_0	output peak-to-average ratio	$PL(AV) = 125$ W at 0.01 % probability on CCDF	3.8	4.3	-	dB

7.1 Ruggedness in class-AB operation

The BLF6G10L-260PRN and BLF6G10L-260PRN are capable of withstanding a load mismatch corresponding to $V_{SWR} = 10 : 1$ through all phases under the following conditions: $V_{DS} = 28$ V; $I_{Dq} = 1800$ mA; $P_L = 260$ W (CW); $f = 920$ MHz to 960 MHz.

7.2 Impedance information

Table 9. Typical impedance per section

$I_{Dq} = 950$ mA; main transistor $V_{DS} = 28$ V

f MHz	Z_S ^[1] Ω	Z_L ^[1] Ω
920	0.7 – j1.0	1.4 + j0.6
940	1.1 – j1.3	1.2 + j0.5
960	1.0 – j1.6	1.2 + j0.3

[1] Z_S and Z_L defined in [Figure 1](#).

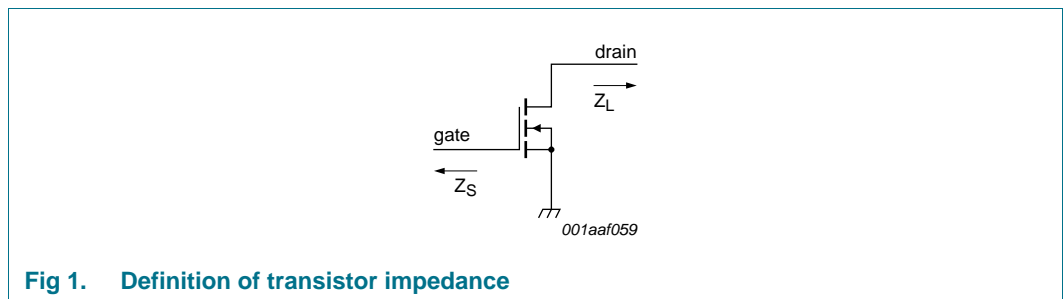
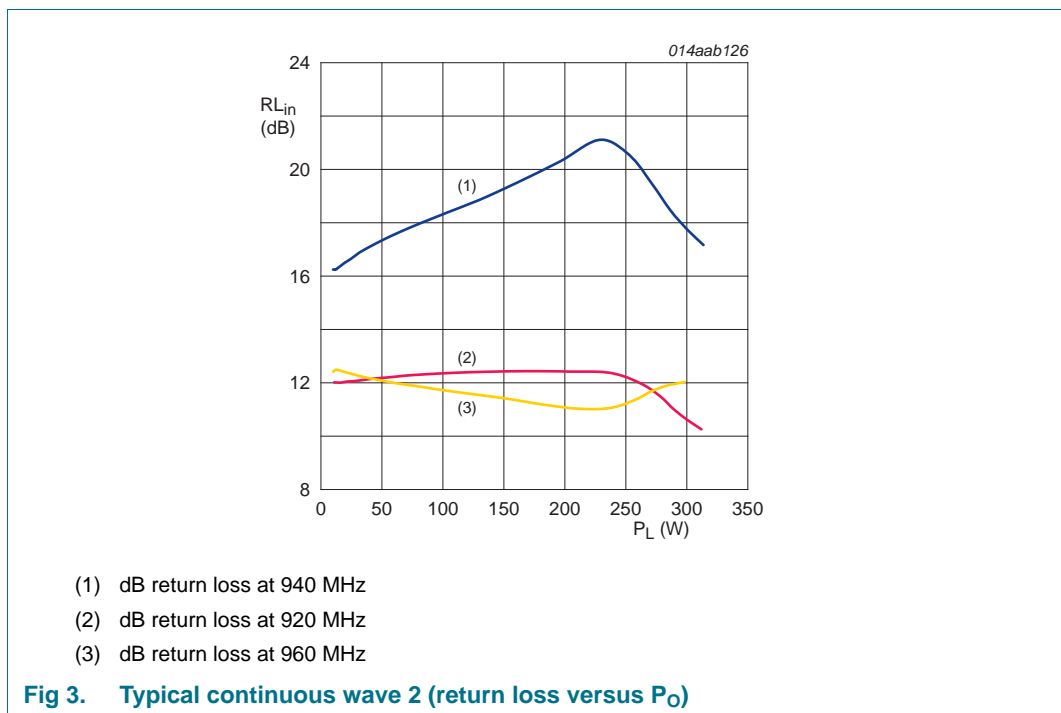
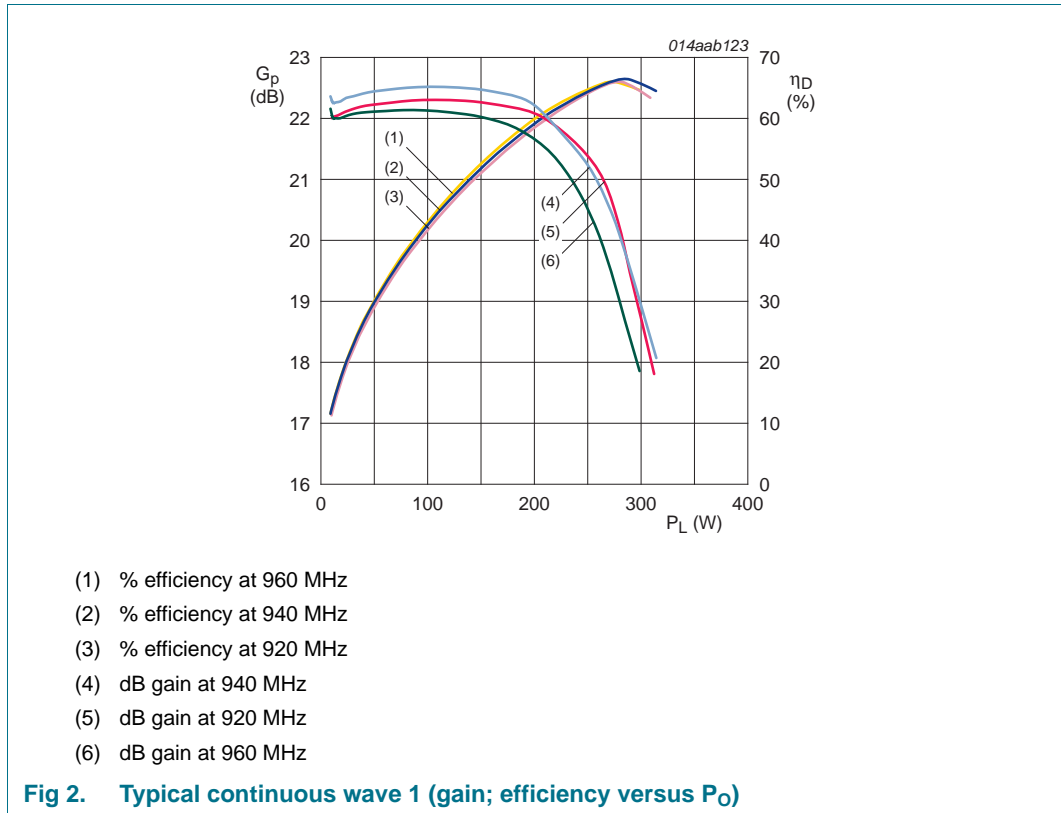

Fig 1. Definition of transistor impedance

7.3 Typical powersweep

7.3.1 CW



7.3.2 IS95

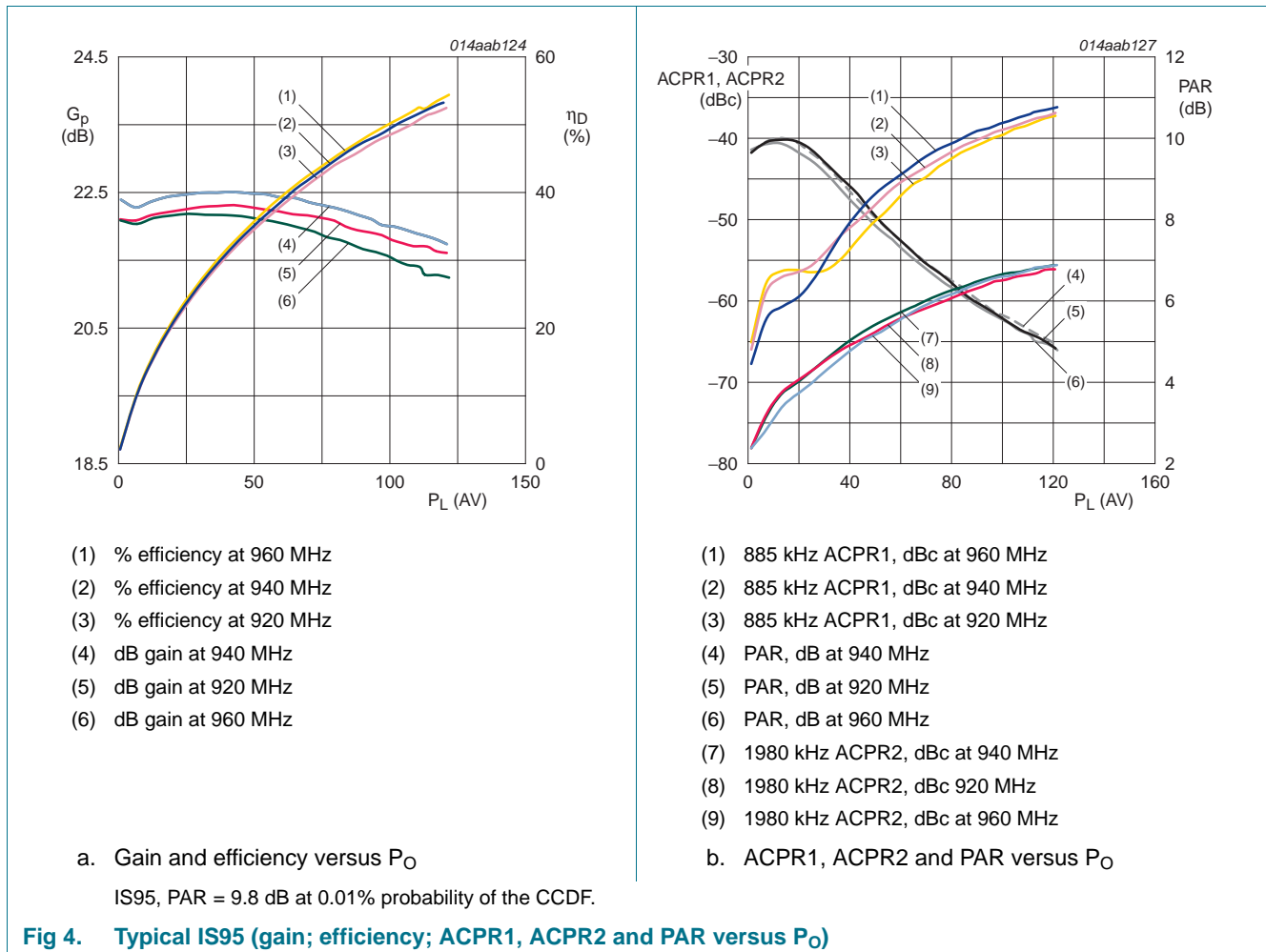

7.3.3 2C-WCDMA (5 MHz spacing)

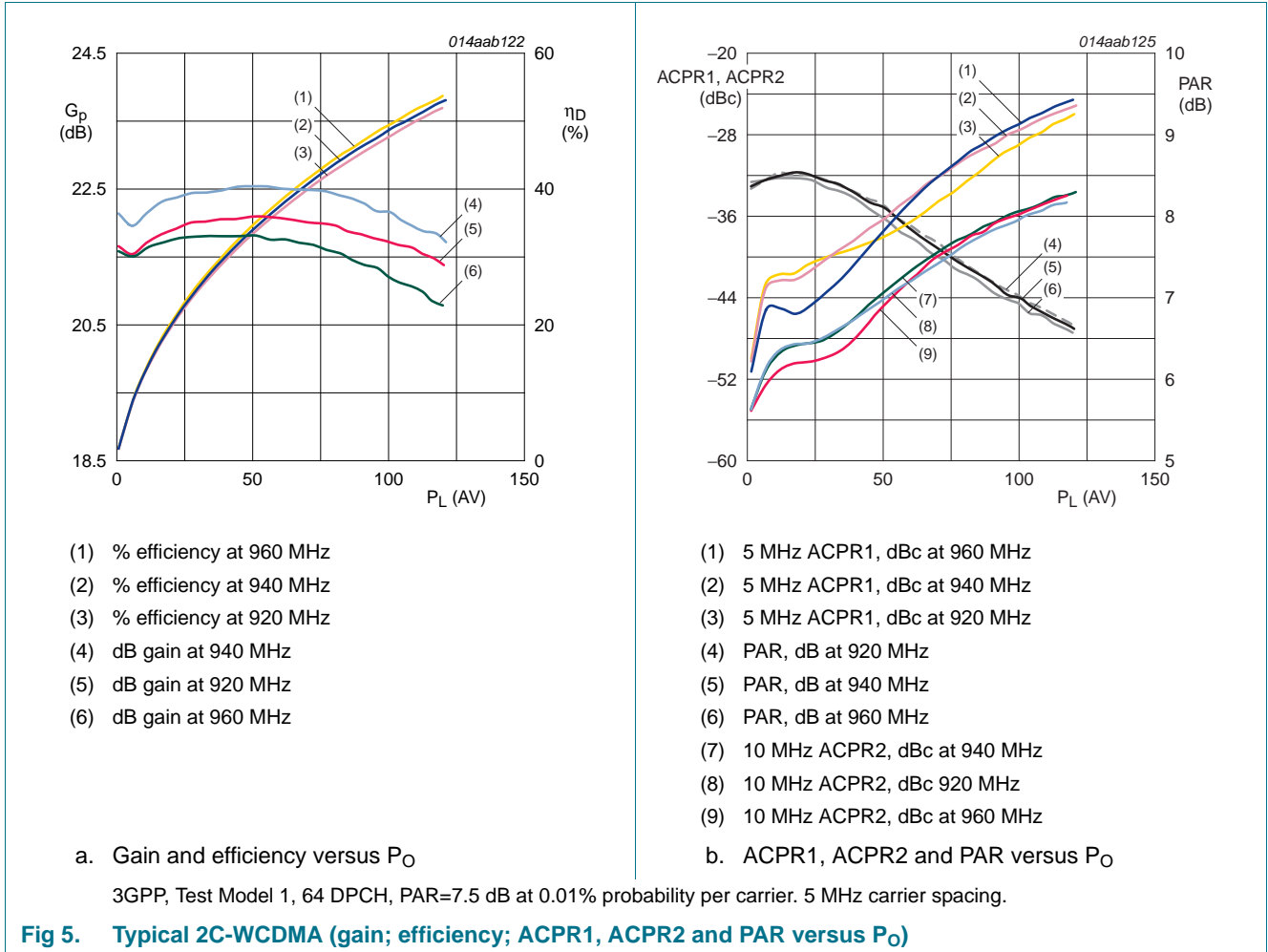
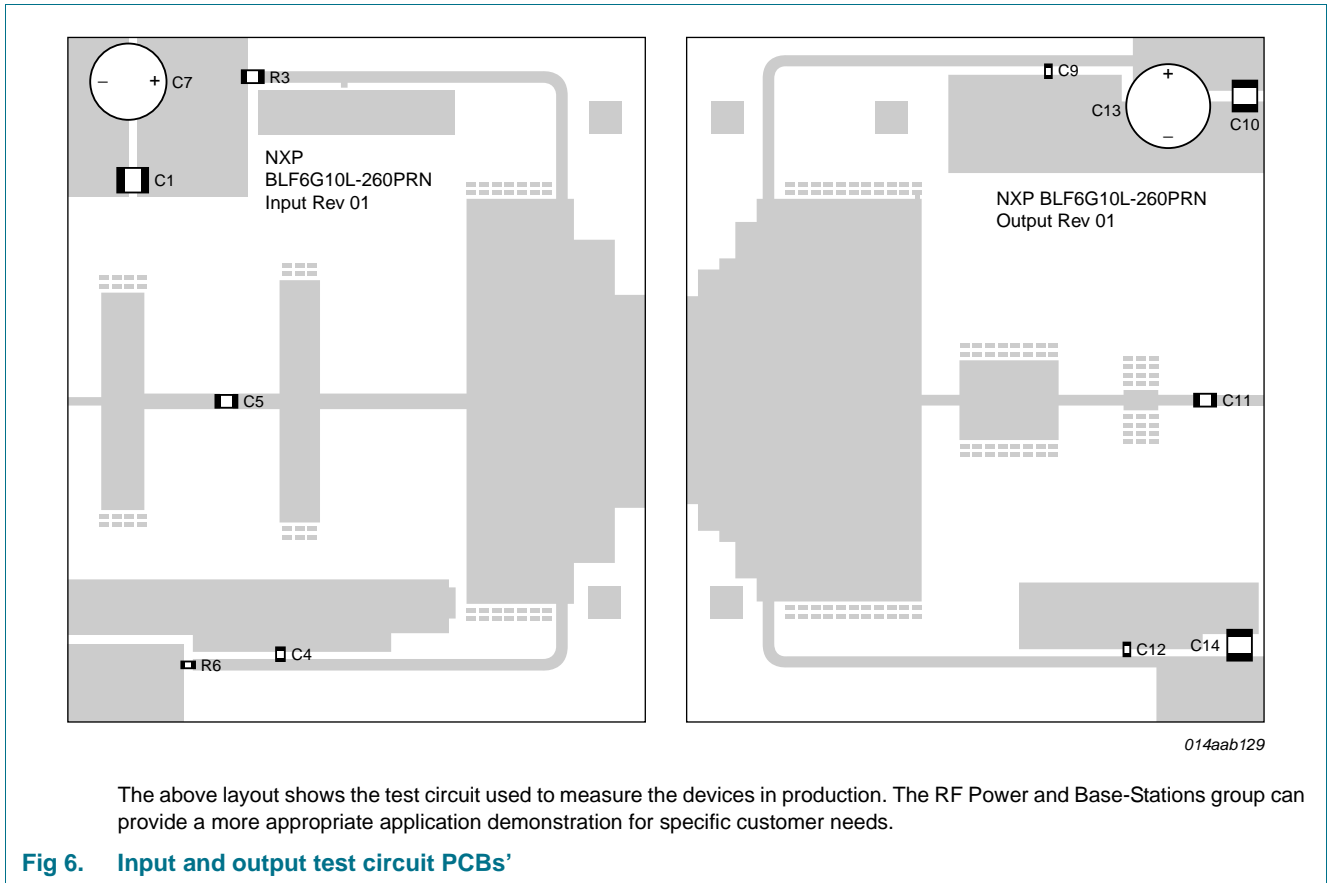

Fig 5. Typical 2C-WCDMA (gain; efficiency; ACPR1, ACPR2 and PAR versus P_O)

8. Test information

8.1 Test circuit

Figure 6 shows the PCB test circuit layout



8.2 Bill of materials (B.O.M.)

The following Bill of materials ([Table 10](#)) shows a list of all the components needed to build the RF test circuit.

Table 10. Bill of materials

Component	Description	Type	Value	Code number	Remarks
	base plate				see mechanical drawing.
	input PCB				see PCB info.
	output PCB				see PCB info.
	15 × bolt M2				brass (nickel plated)
	15 × washer M2				brass (nickel plated)
	4 × contact block		12 × 4 mm		brass (milled)
	rubber O-ring	Viton	17 × 1 mm		
	conductive elastomer ("silver" rubber)	Chomerics	35 × 1 mm (2x)	CHO-SEAL 1273	

Table 10. Bill of materials ...continued

Component	Description	Type	Value	Code number	Remarks
C4, C5, C9, C11, C12	multilayer ceramic chip capacitor	ATC 800B	100 pF		
	multilayer ceramic chip capacitor				
C1, C10, C14	multilayer ceramic chip capacitor	TDK	10 μ F		
C7, C13	electrolytic capacitor		470 μ F		
R3, R6	chip resistor	Philips 0603	10 Ω		
	copper foil strip				needed for tuning
	standard components:				
	N-connector male	13N-50-057/1			Suhner
	N-connector female	23N-50-057/1			Suhner
	4 \times bolt M3		12 mm		chromium nickle steel
	4 \times spring washer M3				chromium nickle steel
	DC-connector 8 pin male	8140-115			Souriau (Farnell)
	2 \times DC-connector 2 pin male	8140-12			Souriau (Farnell)
	2 \times bolt M3		30 mm		chromium nickle steel
	2 \times washer M3				chromium nickle steel
	solid copper wire (diam. 1 mm)		30 mm		
	flexible copper wire	SIMX-F	0.75 mm ²		silicon isolated
	4 \times cable isolator (diam. 3 mm)	P/H30X15WE		1922.000.10134	
	4 \times cable isolator (diam. 2 mm)	P/H20X10WE		1922.000.10033	

9. Package outline

Flanged balanced ceramic package; 2 mounting holes; 4 leads

SOT539A

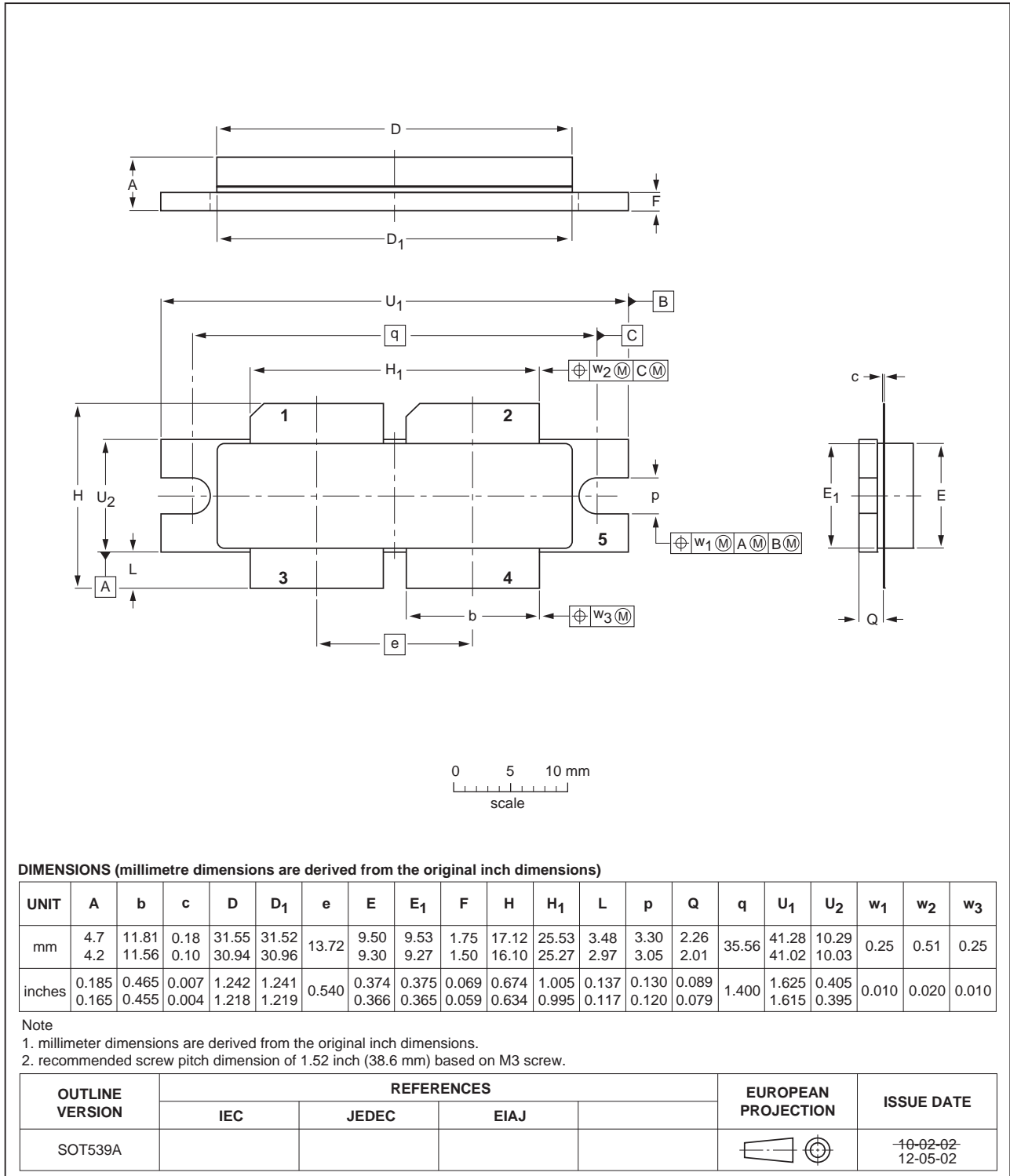

Fig 7. Package outline SOT539A

Earless flanged balanced ceramic package; 4 leads

SOT539B

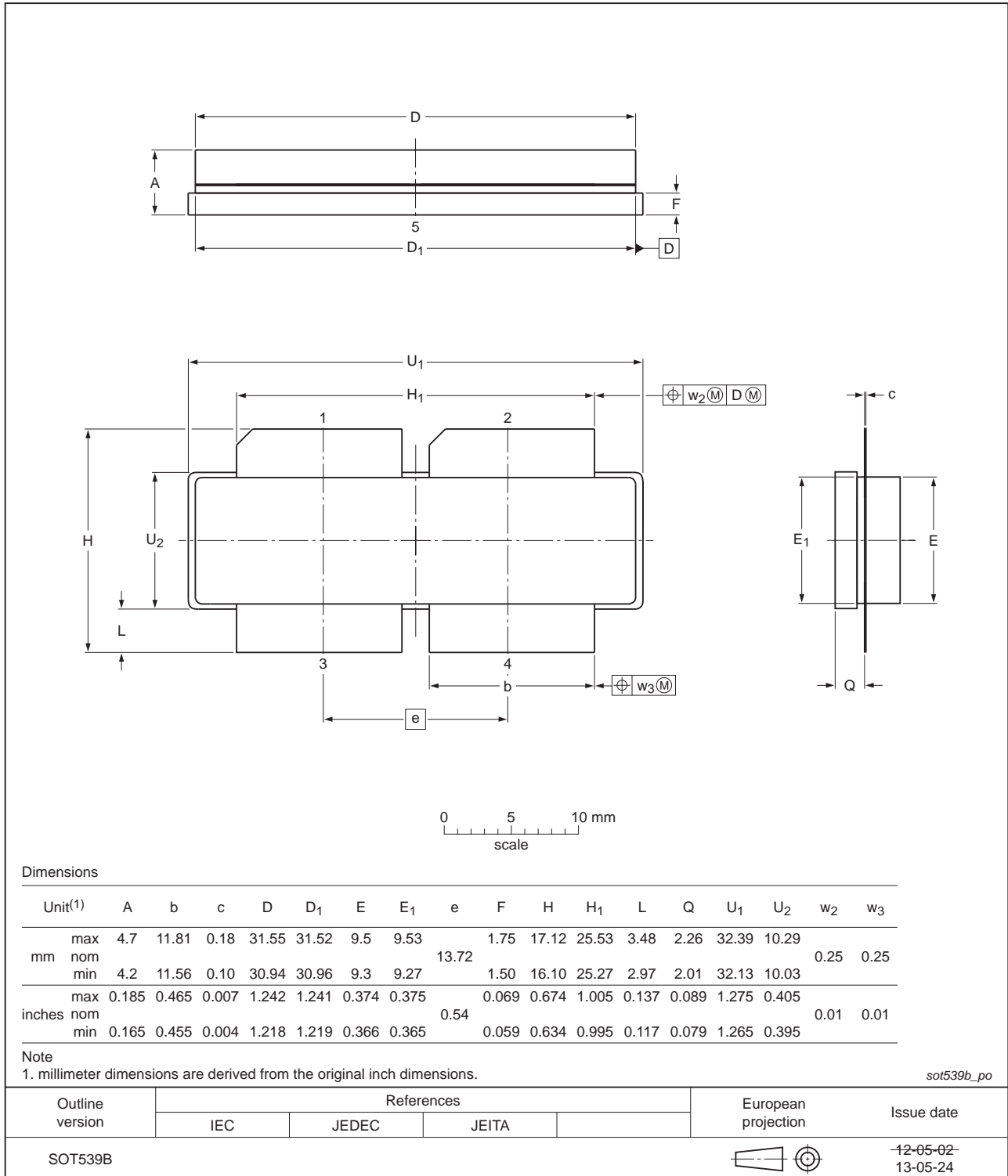

Fig 8. Package outline SOT539B

10. Abbreviations

Table 11. Abbreviations

Acronym	Description
3GPP	Third Generation Partnership Project
CCDF	Complementary Cumulative Distribution Function
CDMA	Code Division Multiple Access
CW	Continuous Wave
DPCH	Dedicated Physical CHannel
EDGE	Enhanced Data rates for GSM Evolution
GSM	Global System for Mobile communications
LDMOS	Laterally Diffused Metal-Oxide Semiconductor
LDMOST	Laterally Diffused Metal-Oxide Semiconductor Transistor
PAR	Peak-to-Average power Ratio
RF	Radio Frequency
VSWR	Voltage Standing-Wave Ratio
W-CDMA	Wideband Code Division Multiple Access

11. Revision history

Table 12. Revision history

Document ID	Release date	Data sheet status	Change notice	Supersedes
BLF6G10L-260PRN_LS-260PRN v.2	20130712	Product data sheet	-	BLF6G10L-260PRN_LS-260PRN v.1
Modifications:			<ul style="list-style-type: none"> The package outline Figure 8 is updated. Translation disclaimer added to the legal text. 	
BLF6G10L-260PRN_LS-260PRN v.1	20100812	Product data sheet	-	-

12. Legal information

12.1 Data sheet status

Document status ^{[1][2]}	Product status ^[3]	Definition
Objective [short] data sheet	Development	This document contains data from the objective specification for product development.
Preliminary [short] data sheet	Qualification	This document contains data from the preliminary specification.
Product [short] data sheet	Production	This document contains the product specification.

[1] Please consult the most recently issued document before initiating or completing a design.

[2] The term 'short data sheet' is explained in section "Definitions".

[3] The product status of device(s) described in this document may have changed since this document was published and may differ in case of multiple devices. The latest product status information is available on the Internet at URL <http://www.nxp.com>.

12.2 Definitions

Draft — The document is a draft version only. The content is still under internal review and subject to formal approval, which may result in modifications or additions. NXP Semiconductors does not give any representations or warranties as to the accuracy or completeness of information included herein and shall have no liability for the consequences of use of such information.

Short data sheet — A short data sheet is an extract from a full data sheet with the same product type number(s) and title. A short data sheet is intended for quick reference only and should not be relied upon to contain detailed and full information. For detailed and full information see the relevant full data sheet, which is available on request via the local NXP Semiconductors sales office. In case of any inconsistency or conflict with the short data sheet, the full data sheet shall prevail.

Product specification — The information and data provided in a Product data sheet shall define the specification of the product as agreed between NXP Semiconductors and its customer, unless NXP Semiconductors and customer have explicitly agreed otherwise in writing. In no event however, shall an agreement be valid in which the NXP Semiconductors product is deemed to offer functions and qualities beyond those described in the Product data sheet.

12.3 Disclaimers

Limited warranty and liability — Information in this document is believed to be accurate and reliable. However, NXP Semiconductors does not give any representations or warranties, expressed or implied, as to the accuracy or completeness of such information and shall have no liability for the consequences of use of such information. NXP Semiconductors takes no responsibility for the content in this document if provided by an information source outside of NXP Semiconductors.

In no event shall NXP Semiconductors be liable for any indirect, incidental, punitive, special or consequential damages (including - without limitation - lost profits, lost savings, business interruption, costs related to the removal or replacement of any products or rework charges) whether or not such damages are based on tort (including negligence), warranty, breach of contract or any other legal theory.

Notwithstanding any damages that customer might incur for any reason whatsoever, NXP Semiconductors' aggregate and cumulative liability towards customer for the products described herein shall be limited in accordance with the *Terms and conditions of commercial sale* of NXP Semiconductors.

Right to make changes — NXP Semiconductors reserves the right to make changes to information published in this document, including without limitation specifications and product descriptions, at any time and without notice. This document supersedes and replaces all information supplied prior to the publication hereof.

Suitability for use — NXP Semiconductors products are not designed, authorized or warranted to be suitable for use in life support, life-critical or safety-critical systems or equipment, nor in applications where failure or malfunction of an NXP Semiconductors product can reasonably be expected to result in personal injury, death or severe property or environmental damage. NXP Semiconductors and its suppliers accept no liability for inclusion and/or use of NXP Semiconductors products in such equipment or applications and therefore such inclusion and/or use is at the customer's own risk.

Applications — Applications that are described herein for any of these products are for illustrative purposes only. NXP Semiconductors makes no representation or warranty that such applications will be suitable for the specified use without further testing or modification.

Customers are responsible for the design and operation of their applications and products using NXP Semiconductors products, and NXP Semiconductors accepts no liability for any assistance with applications or customer product design. It is customer's sole responsibility to determine whether the NXP Semiconductors product is suitable and fit for the customer's applications and products planned, as well as for the planned application and use of customer's third party customer(s). Customers should provide appropriate design and operating safeguards to minimize the risks associated with their applications and products.

NXP Semiconductors does not accept any liability related to any default, damage, costs or problem which is based on any weakness or default in the customer's applications or products, or the application or use by customer's third party customer(s). Customer is responsible for doing all necessary testing for the customer's applications and products using NXP Semiconductors products in order to avoid a default of the applications and the products or of the application or use by customer's third party customer(s). NXP does not accept any liability in this respect.

Limiting values — Stress above one or more limiting values (as defined in the Absolute Maximum Ratings System of IEC 60134) will cause permanent damage to the device. Limiting values are stress ratings only and (proper) operation of the device at these or any other conditions above those given in the Recommended operating conditions section (if present) or the Characteristics sections of this document is not warranted. Constant or repeated exposure to limiting values will permanently and irreversibly affect the quality and reliability of the device.

Terms and conditions of commercial sale — NXP Semiconductors products are sold subject to the general terms and conditions of commercial sale, as published at <http://www.nxp.com/profile/terms>, unless otherwise agreed in a valid written individual agreement. In case an individual agreement is concluded only the terms and conditions of the respective agreement shall apply. NXP Semiconductors hereby expressly objects to applying the customer's general terms and conditions with regard to the purchase of NXP Semiconductors products by customer.

No offer to sell or license — Nothing in this document may be interpreted or construed as an offer to sell products that is open for acceptance or the grant, conveyance or implication of any license under any copyrights, patents or other industrial or intellectual property rights.

Export control — This document as well as the item(s) described herein may be subject to export control regulations. Export might require a prior authorization from competent authorities.

Non-automotive qualified products — Unless this data sheet expressly states that this specific NXP Semiconductors product is automotive qualified, the product is not suitable for automotive use. It is neither qualified nor tested in accordance with automotive testing or application requirements. NXP Semiconductors accepts no liability for inclusion and/or use of non-automotive qualified products in automotive equipment or applications.

In the event that customer uses the product for design-in and use in automotive applications to automotive specifications and standards, customer (a) shall use the product without NXP Semiconductors' warranty of the product for such automotive applications, use and specifications, and (b) whenever customer uses the product for automotive applications beyond

NXP Semiconductors' specifications such use shall be solely at customer's own risk, and (c) customer fully indemnifies NXP Semiconductors for any liability, damages or failed product claims resulting from customer design and use of the product for automotive applications beyond NXP Semiconductors' standard warranty and NXP Semiconductors' product specifications.

Translations — A non-English (translated) version of a document is for reference only. The English version shall prevail in case of any discrepancy between the translated and English versions.

12.4 Trademarks

Notice: All referenced brands, product names, service names and trademarks are the property of their respective owners.

13. Contact information

For more information, please visit: <http://www.nxp.com>

For sales office addresses, please send an email to: salesaddresses@nxp.com

14. Contents

1 Product profile 1

1.1 General description 1

1.2 Features and benefits 1

1.3 Applications 2

2 Pinning information 2

3 Ordering information 2

4 Limiting values 3

5 Thermal characteristics 3

6 Characteristics 3

7 Application information 3

7.1 Ruggedness in class-AB operation 4

7.2 Impedance information 4

7.3 Typical powersweep 5

7.3.1 CW 5

7.3.2 IS95 6

7.3.3 2C-WCDMA (5 MHz spacing) 7

8 Test information 8

8.1 Test circuit 8

8.2 Bill of materials (B.O.M.) 8

9 Package outline 10

10 Abbreviations 12

11 Revision history 12

12 Legal information 13

12.1 Data sheet status 13

12.2 Definitions 13

12.3 Disclaimers 13

12.4 Trademarks 14

13 Contact information 14

14 Contents 15

Please be aware that important notices concerning this document and the product(s) described herein, have been included in section 'Legal information'.

© NXP B.V. 2013. All rights reserved.

For more information, please visit: <http://www.nxp.com>
 For sales office addresses, please send an email to: salesaddresses@nxp.com

Date of release: 12 July 2013

Document identifier: BLF6G10L-260PRN_LS-260PRN